



# IJRASET

International Journal For Research in  
Applied Science and Engineering Technology



---

# INTERNATIONAL JOURNAL FOR RESEARCH

IN APPLIED SCIENCE & ENGINEERING TECHNOLOGY

---

**Volume: 8**

**Issue: IV**

**Month of publication: April 2020**

**DOI:**

[www.ijraset.com](http://www.ijraset.com)

Call:  08813907089

E-mail ID: [ijraset@gmail.com](mailto:ijraset@gmail.com)

# A Literature Review on Student Enrollment & College Administration Automation System

Prof. S. K. Penchala<sup>1</sup>, Tejas B. Makde<sup>2</sup>

<sup>1</sup>CSE Department, <sup>2</sup>M-Tech CSE 2<sup>nd</sup>Year(4<sup>th</sup> Sem), G.H Rasoni College of Engineering, Nagpur, Maharashtra, India

**Abstract:** Now a day's technology has back-geared such a lot that the quantity of scholars taking admission in Engineering or any schools apart from engineering area unit increasing day-by-day. So, we've targeted towards developing an online electronic network that's Student Enrollment & College Administration Automation (SECAA) that is of importance to either an educational institution or a university.

Although some schools have already applied this technique however there are a unit still some procedures that area unit being done by paper work solely by standing in line to indicate the receipt and every one. So, we have a tendency to area unit creating a system that the work are done on-line from admission procedure until the payment of fees or the unfinished fees left and it'll updated within the system with none paper procedures.

## I. INTRODUCTION

Digitization could be a process that manages the system in many organization's work. As it reduces the errors and interval which can be occurred by the humans; therefore it will boost productivity and resulted into prime quality of work can be done by the employees of the organization. The purpose of this study is to reduce the manual and tedious work in the manual enrollment and management system. This may lead to a system with well-integrated processes which will perform a lot of quicker and a lot of correct than a manual system.

Enrollment mean it is confirmatory information of student to register on specific course. Totally different reticular processes build up enrollment procedures known as Enrollment System. Enrollment Systems square measure used notably in recording and retrieving student's data. Following student's data is additionally one feature of Enrollment Systems, within which the varsity will trace the standing of a student. Confirmatory payments were conjointly adscititious to update or browse student's billings.

Online Enrollment System could be an exemplar of a pc generated method. This may reduce the work and provides correct data required of the varsity. As a result, it'll profit not solely the coed however the administration as an entire.

Online Enrollment System is extremely essential in a very faculty. Within the case of different colleges, it's composed of a manual system. Directress used manual system in recording and retrieving student's data. She conjointly has data regarding student's payment. In fact, she wills all the record keeping simply by victimization ball pen and columnar sheet. On the opposite hand, Registrar Department conjointly used manual system as the way of recording and retrieving student data. Another department is Accounting workplace that administers student's payment manually.

Above our observation, human interventions can extremely involve during this kind of system. As a result, this could involve errors and redundancy of information ensuing troubles in organization.

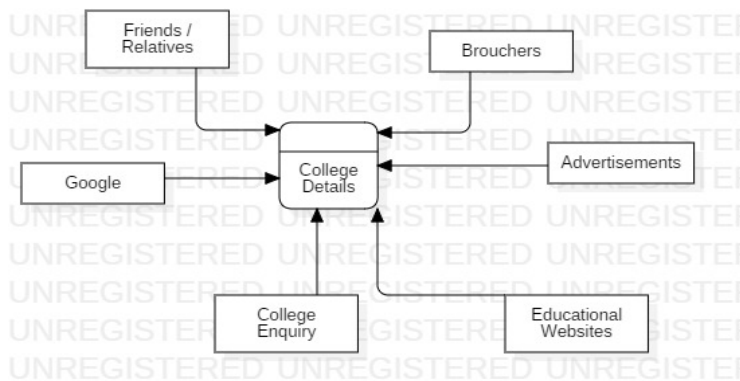

Student getting information by different means which is shown in above figure.

## II. LITERATURE SURVEY

In our nation, developing with field goes on to the foremost extreme significance within the foremost up-to-date decade.

Absolutely different components of Engineering have picked up infamy transfer with reference to a really high variety of understudy confirmations systematically. Attributable to the developing interest within the amount of seats absolutely utterly totally different universities are store-bought that encourage these needs. Systematically associate in nursing oversized variety of understudies take confirmation for engineering everywhere Republic of country.

The board of directors of Technical Education for every state deals with the confirmation procedure for building. Yet, the administration of confirmation at the school level is crucial no absolutely utterly totally different. Despite the particular undeniable fact that the DTE offers a Centralized Admission technique, that is on net, for understudies to be very admitted to the school, there have to be compelled to be Associate in Nursing extended strategy to be pursued physically at the school. Attributable to the exceptionally high vary of understudies choosing every academic year, the work faculty level increment exponentially. This work have to be compelled to be done physically.

The overwhelming majority of the colleges try this work physically whereas some of universities utilize the framework that is over the absolute best price and not versatile. On account of a manual framework, it takes an honest deal of your time and labour whereas this frameworks sway the funds of the school as they're SaaS-based and for the foremost charge per understudy. There's besides a demand for enrollment and structure filling that is likewise done physically to be mechanized.

There is a requirement for a framework which may be introduced regionally within the institution and that might robotize the dreary procedure of manual confirmation. Throughout this fashion, we'll investigate absolutely utterly totally different conceivable outcomes wherever one does not thought to be compelled to be compelled to utilize the manual framework or any expensive arrangement of fruitfully alter the understudies' info and information.

According to Ford Apache might be a strong net server styled with a typical design to be every economical and portable. It's very versatile, providing the flexibility for a single server to support multiple websites as virtual hosts and to act as internet proxy. Apache includes customary modules for caching, to supports SSL/TLS connections, varied authentication and authorization mechanisms, and filtering system. there's a unit many add-on modules that stretch Apache's utility providing choices, like tinplating engines, embedded interpreters for many scripting languages, and machine readable text transfer protocol interfaces to systems just like the Subversion system.

This packet reference summarizes Apache's command-line chance and so the configuration directives for the modules at intervals the customary distribution. It covers Apache version 2.2.9, however, most data applies to any version of Apache 2. For comprehensive information, the scale of that's on the so much facet the scope of a small low guide like this, the Apache documentation data processor have to be compelled to be your next purpose of referral.

Apache is generally run as a system daemon or service, with a parent method or thread oversight variety of kid processes or threads that perform the request process. A neighborhood from bound core feature, most practicality is enforced by modules, which can be either statically connected into the server dynamically loaded on startup.

Operating systems vary in but they implement choices like networking and multiprocessing. Apache version 2.0 introduced Multi method Modules (MPMs) to provide networking and designing models tailored to specific package and usage patterns. MPMs use the native choices of the package and provide designing practice processes, threads, or a mix of the two. Apache uses entirely one MPM at any time, and it ought to be statically compiled into the server.

According to Pouncey I., York R.. Cascading vogue Sheets (CSS) might be a language designed for describing the appearance of documents written throughout a language like terminology. With CSS you will be able to management the color the text, the style of fonts, the spacing between paragraphs, but columns unit sized and organized out, what background footage or colours unit used, and a diffusion of various visual effects. one in every of the foremost necessary blessings is that constant CSS area unit usually used by over one page, which means that the style of an entire data processor area unit usually adjusted whereas not having to by over one page, which means that the style of an entire data processor area unit usually adjusted whereas not having to change page one by one.

The commonest use for CSS is to vogue web page, and beside terminology or XHTML (which is used to clarify content) and JavaScript (which is used to feature interactivity to a site). CSS might be a really powerful tool. At intervals the youth of net, nine utterly totally different proposals were created to the world Wide net syndicate; the foremost standards organization for net that's a great deal of typically cited because the W3C, for a way sheet language to help separate the visual look of a document from its content. In 1994, Cascading terminology vogue Sheets was projected by Hakon Wium Lie, presently CTO of Opera code, but at the time he was engaging at CERN with Tim Berners-Lee and Henry Martyn Henry Martyn Robert Cailliau, the two men fictitious the

world Wide net. CHSS become CSS as a results of CSS is usually applied to over merely terminology, and in Gregorian calendar month 1996 the CSS level one Recommendation was written.

Since then, there a great deal of CSS specifications area unit written by the W3C. CSS2 became a recommendation in 1998, with CSS 2.1 and CSS 3 presently existing as candidate recommendations.

Although CSS 3 continues to be at a lower place development, CSS 2.1 is maybe getting to become a much fledged recommendation at intervals the on the brink of future and is well supported by all modern browsers. By practice CSS for the presentation of a document, you will be able to well cut back the amount of some time you pay composing not entirely one document but an entire data processor. As you'll discover, CSS is way a great deal of versatile than the styling mechanisms provided by terminology alone. The flexibleness of CSS, once controlled effectively, can cut back the amount of storage device house that an internet web site occupies, and moreover as a result of the amount of knowledge live required to transmit that data processor from the server to the browser.

According to Holzner S., et al, (2009). JQuery is Associate in nursing code document JavaScript kit for building net applications so dynamic they begin the page. Filled with special controls like calendars and so the folders, and tricks like wipes and fade-ins, jQuery is gaining quality chop-chop.

Perhaps most vital, jQuery provides you tremendous support for Ajax applications. Ajax is what permits you to access an online server from a browser whereas not a page refresh-that is, there's no blinking, no flicker once you transfer information behind the scenes with Ajax; you just transfer the data then you will be able to show it throughout a web page practice dynamic terminology techniques. No-fuss no muss- and so the result is Associate in a nursing application that seems plenty of types of a desktop application that an online application.

With Ajax, the user can do one factor throughout a browser page, and so the results of their action look instantly, updated currently at intervals the browser window, whereas not poignant the other contents of the window.

JQuery Associate in nursing code document JavaScript kit for building net application so dynamic, they begin the page. Filled with special controls like calendars and tab folders, and results like wipes and fade-in, jQuery is gaining quality chop-chop. Specialized in possession you opt on half throughout a page and it'll above any wrapped sets of components at constant time.

JQuery might be a JavaScript library jam-packed with tools able to be used – which means that its prewritten JavaScript, ready for you to position to work on your web page. Throughout this book, you get a guided tour of what makes jQuery so modern.

JQuery focuses on possession you opt on components throughout a page, and it'll that well than the opposite JavaScript library. You'll see the simplest way to provide wrapped sets of components in jQuery, so you will be able to handle multiple components at constant time. You'll, also, see the simplest way to control wrapped sets of components by dynamic their look, style, visibility, and even their terminology.

JQuery, also, comes filled with super-power-full utility functions, like functions that permit you to determine what browser the user has and what its capabilities unit. JQuery provides many utility functions and you'll get look at the foremost effective ones throughout this book. jQuery is known for its visual effects that embrace slick-looking wipes, at intervals that a sheet of color wipes over half, and fades, at intervals that half and its background fade from scan.

According to King T. Reese, MySQL is open in every sense of the term of its SQL voice communication uses ANSIS SQL2 as its foundation. The data engine runs on myriad platforms, likewise as Windows 2000, Mac OS X, Linux, FreeBSD, and Solaris. If no binary is gettable for your platform, you've got access to the provision to compile to that platform.

MySQL has Associate in Nursing API for close to any programing language. Specifically, you will be able to write info applications those applications that access MySQL in C, C++, Eiffel, Java, Perl, PHP, Python, and Tcl.

MySQL supports several utterly different character sets, likewise as ISO-8859-1, Big5, and Shift-JIS. It, also, supports sorting for numerous character sets and can be custom merely. Error message area unit usually provided in many languages moreover. MySQL compares well with totally different free info engines. It blows them away, in terms of performance.

MySQL does not compare with MySQL on any level. Instant compares moderately on a feature level, but MySQL continues to be a great deal of faster. PostgreSQL has some cool SQL3 options; but it carries the bloat of business info engines. If you're viewing low-cost info engines and area unit practice advanced SQL3 choices, you nearly definitely would like PostgreSQL.

Like many applications, MySQL contains a check suite that verifies that a freshly compiled system can thus support all the choices it's purported to support whereas not breaking. The MySQL team calls it to check suite "crash-me" as a results of one in each of its choices is to try to to crash MySQL.



Somewhere on the tactic, someone detected that crash I was a transferrable program. Not entirely may it work on different operative systems, but you will use it to see utterly different info engines. Since that discovery, crash-me has evolved from a simple check suite into a comparison program. The different info engines. Since that discovery, crash-me has evolved from a simple check suite into a comparison program. The tests embrace all of normal SQL moreover as extensions offered by many servers. Besides, the program tests the dependability of the server at lower place stress. A whole check run provides a through an image of the capabilities of the data engine being tested.

MySQL might be an electronic information service management system. It includes not entirely a server technique to manage databases, but also tools for accessing the data and building application against that information.

The Structured language (SQL) is used to scan and write to MySQL databases. Using SQL, you will be able to search for, enter, modify, or delete info. SQL is that the foremost basic tool you will need for your interactions with MySQL. Although you are victimization some application or graphical interface to access the information, somewhere beneath the hood that application is generating the information.

SQL might be a spread of “natural” language. In several words, associate SQL statement have to be compelled to scan – a minimum of on the surface – type of a sentence of English text. This approach has every blessings and downsides; but the highest result's a language not like ancient programming languages like C, Java, or Perl.

According to Holzner, PHP represent “PHP” electronic text Pre-processor”, but it's in addition legendary around the world for its original name, Personal Home Page. It's the server side language that's taken the cyber world by storm - PHP is far and away the foremost modish language to be used on net servers. That's the conception behind PHP: having the flexibility to undertake and do some easy programming on net server, creating everything from on-line data to guest books, from shopper schedulers to talk rooms, from file uploading tools to wanting carts. It's all possible with PHP.

Where did PHP come from? PHP user's area unit usually began to find out that PHP has been around for quite some time; it had been created by Rasmus Lerdorf in 1994 (Rasmus needed the best means of labor WHO was observant his on-line resume). PHP got such an honest name that by 1995 it had been on the market to be employed by others, and so the PHP revolution was current.

PHP at first was known Personal Home Page, or Personal Home Page Tools. At that time, as you will expect, PHP was really easy, and can be accustomed manufacture web page hit counters, guest books, and so sort. The 1995 version of PHP was called PHP/FI Version a try of.

In time, Rasmus alternative support for interfacing with mini SQL (MySQL), associated PHP/FI started growing at astonishing rate as a great deal of parents contributed code to that. There was a real need for a straightforward web server language then, and so the range of PHP pages merely unbroken growing. In 1996, PHP/FI was already obtaining employed by regarding fifteen thousand web page. In 1997, that selection grew to over fifty thousand.

Today, PHP is everywhere you look on net, with associate calculable 100 million PHP pages (it's exhausting to induce correct statistics-if you're doing a quest on Google for PHP, as an example, you get associate astounding calculable a try of, 7400, 00,000 hits). PHP remains trustworthy its original name: Personal Home Page, as a results of it offers you the simplest because of as a result of you to websites change on the server. But PHP has in addition become a very skilful language, acceptable for top-notch sites.

According to Delisle M. PhpMyAdmin is associate open provide web interface that handles the administration of MySQL. It will perform varied tasks like creating, modifying, or deleting databases, tables, columns, or rows. It can execute SQL statements which can manage users and their permission. Once it involves exploiting PhpMyAdmin to its full potential, even older developers and system administrators searched for tutorials to accomplish their tasks.

PhpMyAdmin might be a web application written in PHP; it contains XHTML, CSS, and JavaScript client code. This application provides an entire new interface for administering MySQL data, and is wide illustrious as a result of the leading application throughout this field.

Being open provide since its birth, it's enjoyed support from numerous developers and translators worldwide. The project is presently hosted at SourceForge.net and developed victimization their facilities by the PhpMyAdmin team.

Host suppliers everywhere area unit showing their trust in PhpMyAdmin by setting up it on their servers. The favoured cPanel (a data processor management application) contains PhpMyAdmin. In addition, we tend to area unit able to install our own copy of PhpMyAdmin on our web server as long as our provider's server satisfies with the minimum requirements.

The goal of PhpMyAdmin is to provide an entire web-based management of MySQL servers and knowledge, and to remain America with MySQL and web standards evolution. Whereas the merchandise is typically evolving, it supports all customary operations beside more choices.

PhpMyAdmin offers choices that cover basic MySQL data and table operations. It in addition has an interior system that maintains information supports advanced feature. Finally, system administrators can manage users and privileges from PhpMyAdmin. It's necessary to note that

PhpMyAdmin's choice of gettable operations depends on the rights the user has on a particular MySQL server.

In the paper, "An analysis Paper on school Management System" the author has come up with a structure for the system where the tactic of coming Paper on school Management System" the author has come up with a structure for the system where the tactic of coming back into the information and viewing the information is elaborated. However, it's its demerits, as a result of the system does not allow integration of the admission technique or communication technique that have to be compelled to be integrated for next level of automation.

AUTHOR	METHOD AND DESCRIPTION	ADVANTAGES	DISADVANTAGES
[1]Lalit Mohan Joshi "A Research Paper on College Management System"	To provide a login system for the admins to update the information and the students to view the marks, exams schedules etc.	The software is very robust. Can be adapted in any small scale educational institute because it is very cheap and relatively faster.	It does not have an integrated system for admissions which is needed mainly for high volume admission process.
[2]Josep Cobrasi "Campus Information Systems for Colleges"	The system was designed for implementation on large campuses with integrated housing for students. It provides major modules like Academics, Social and Administrative	It gave a full proof method for large campuses and provided an easy academic as well as housing management system.	This system can be very expensive to implement as it requires multiple nodes and servers to be implemented.

In the paper "Campus info Systems for Colleges", the author has researched on a system that will facilitate institutes integrate management system with a social module, that won't a requirement for all the institutes. It in addition integrates a Housing module that helps permits the institutes to manage the data for the hostels and totally different facilities. India's establishment system is that the third largest at intervals the globe. The foremost necessary governing organization at tertiary level is that the University Grants Commission. That enforces its principles, advises the government, and lends a hand to arrange between the centre and so the state? Official recognition for higher learning is overseen by twelve freelance institutions recognized by the University Grants Commission. As of 2009, India incorporates a try of central university 215 state universities, 100 deemed universities, 5 institutions established and ending beneath the state act, and 13 institutes that area unit of national importance. Totally different institutions embody 16000 schools, likewise as 1800 exclusive women's schools, functioning beneath these universities and organizations.

### III. DESCRIPTION OF PLANNED SYSTEM

The purpose of this analysis aims to develop an internet Enrollment System style for the advantages of enrollees and for the administrator employees of the varsity and to assist the colleges for having that quick and correct enrollment system flow.

This project is on-line entry system for college kids. It retrieves and collects details of scholars with enrollment assessment method that manufacture elaborates reports. It's going to even be use as native and on-line assessment of the scholars. The System is style to retrieve and track the info in a very quicker, easier and safe means by storing file knowledge of the college enrollees within an info which can reduce the hassle of college employees. These details here can be seen in a very second while not having to threat that the one knowledge lost. It's conjointly practicality that may access through net that creates students simply read and supply data.

The new on-line Enrollment System can have own login page for the college to look at their profile with their college assessment and conjointly advertise the varsity. And conjointly the executive login page to secure and manage the assessment kind, student profile and elaborate reports.

The below figure shows how our system will work considering each phase of the college management system whether it's Admin phase, department phase or Teacher-student EMS login.

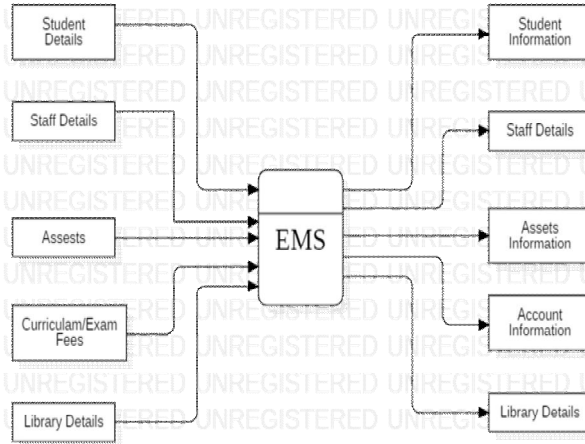

EMS - Enrollment Management System

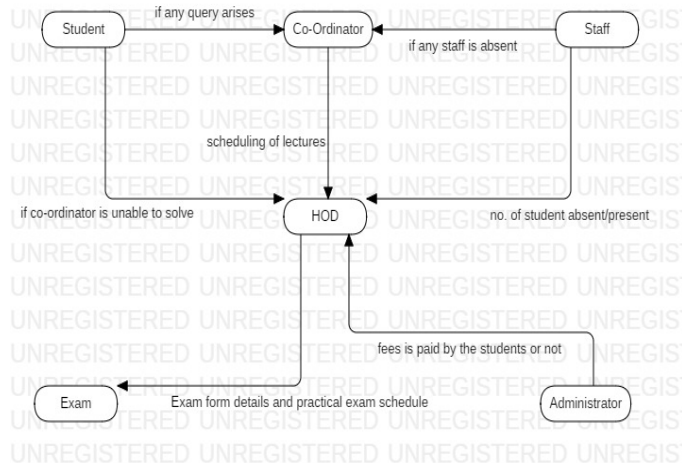
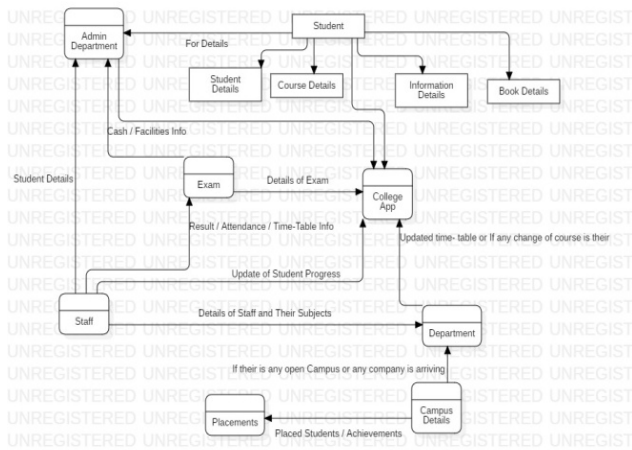

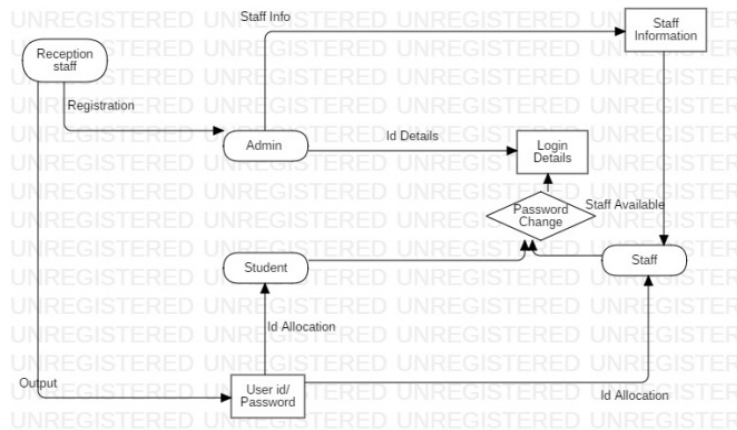
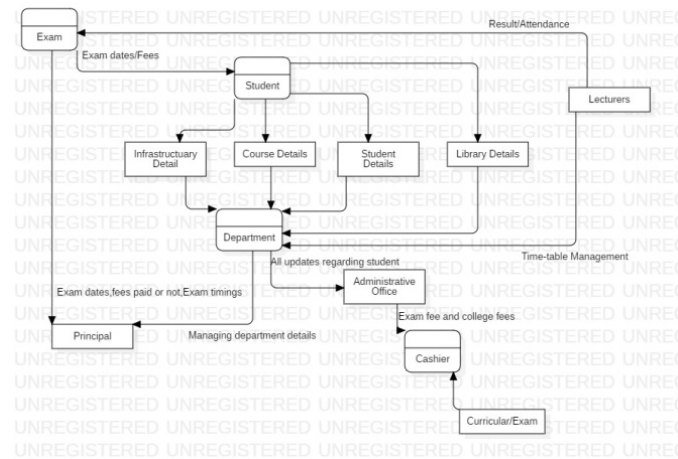
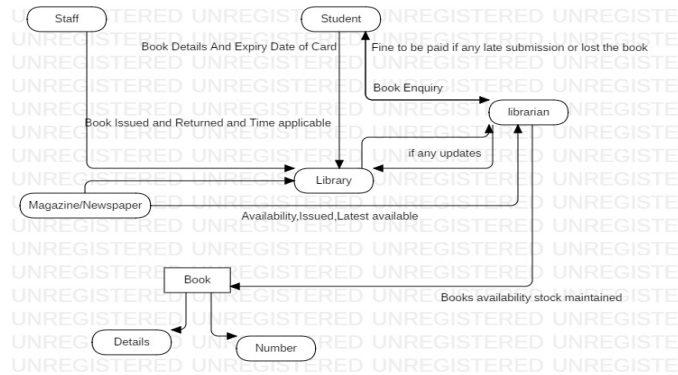

#### IV. OBJECTIVE

The objectives of the study titled on-line Enrollment System for colleges that measure the following:

- A. To produce the answer with their drawback on Manual enrollment System that might create the enrollment quick, easier and safe every enrollment method. Safely stores all the records, information, and knowledge of the new and recent students
- B. To help the scholars and employees of the college measure suffering the time overwhelming, slow, inaccurate and manual enrollment system.
- C. To propose an internet Enrollment System that customizes and suit the requirements of the college system that can reduce the employment and paper works of the staff and boost the system and procedure of the entry method.



## V. SCOPE AND LIMITATIONS

The Net Enrollment system concentrates gathered enrollment knowledge from students that contains and indicates the fees, subjects and student records like basic info, contacts and address.

This can function a registration kind document done through on-line and offline processed kind which will be enable student and workers access and examine simply. It'll offer enrollment history each group action for each student that may be manages in a straightforward means while not having to stress that the one knowledge lost. The net Enrollment System is allotted to style associate degree economical and effective system once it involves speed, dependableness and accuracy reports.

The system turn out solely the generate Fees slip that to be physically given upon manual payment. Conjointly the schedule of the scholars isn't enclosed since it'll provide once the enrollment method done. The accounting report is additionally limit as well as the invoice receipt and different payment kind

## REFERENCES

- [1] Mrs. M.S.Malkar, Pankaj R Gopalani, Gauri N Basutkar, Raj D Garud, Prachi P Rukari "An Android Application for Smart College (Volume 5 Issue 2) 2018
- [2] Pravin Pariskar, Aishwarya Tamboli "Institute Administration Automation and Student Database Management System" International Journal of Advance Research, Ideas and Innovations in Technology (Volume3, Issue2) 2017
- [3] Ford, Andrew (n. d). For programmer and administrator. Apache, 2
- [4] York Richard (2009) Beginning CSS: Cascading Style Sheets for Web Design (Wrox Programmer to Programmer)
- [5] Steven Holzner (2009). XML: A Beginner's Guide: Go Beyond the Basics with Ajax, XHTML, XPath 2.0, XSLT 2.0 and XQuery (Beginner's Guides (McGraw-Hill)
- [6] Reese G. Yarger R.J. King T. (2010) MANAGING & USING MYSQL 2nd edition
- [7] Steven Holzner (2009). PHP: The Complete Reference
- [8] Delisle M. Mastering PHP My Admin 2.8 for Effective MySQL Management (2008)
- [9] Lalit Mohan Joshi "A Research Paper on College Management System" - International Journal of Computer Applications (0975 – 8887) Volume 122 – No.11, July 2015
- [10] Gina M. Almerico "Applying Database Technology for Student Record Automation" - Florida Association of Teacher Educators Journal Volume 1 Number 4 2004 11-25 Josep Cobrasí "Campus Information Systems for Colleges" CWIS 25, 1
- [11] Wireless LAN Medium Access Control (MAC) and Physical Layer (PHY) Specification, IEEE Std. 802.11, 1997.



10.22214/IJRASET



45.98



IMPACT FACTOR:  
7.129



IMPACT FACTOR:  
7.429



# INTERNATIONAL JOURNAL FOR RESEARCH

IN APPLIED SCIENCE & ENGINEERING TECHNOLOGY

Call : 08813907089  (24\*7 Support on Whatsapp)